

Sidecar 24



Model shown paired with Cube 24
side table by Blinde Design



Sidecar 24 Design features

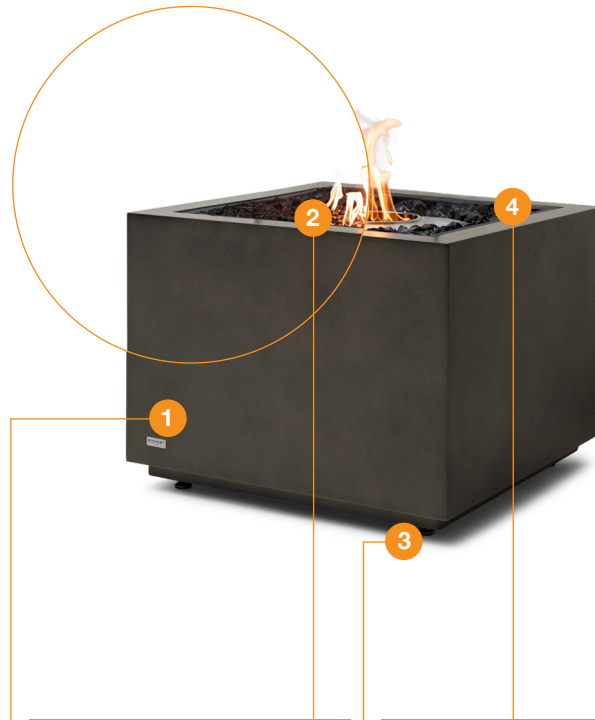

1. Fluid™ Concrete Finish
Incredibly strong yet relatively lightweight, EcoSmart's concrete products incorporate revolutionary Fluid Concrete Technology. Fluid features a stain and impact-resistant barrier that protects the concrete from environmental weathering – even under extreme conditions and long UV exposure.

Surround Colours/Finish
Available in three Fluid Concrete colours: Natural, Graphite and Bone.

2. Burner Colours
Available with a Stainless Steel or Black Burner.

3. Articulating Feet
Our Fire Pits and Tables feature 360° height-adjustable articulating feet, so you can achieve a perfectly level and stable model before operating the fireplace.

Quick & Easy Installation
With no installation or building works required, simply unpack, put into position, and off you go.

4. Decorative Media
Models come with black glass charcoal to add the finishing touch. They do not emit any toxic fumes, smoke, or ash and are extremely easy to maintain and clean.

Environmentally-Friendly
Bioethanol fireplaces use an environmentally-friendly, renewable energy source that burns clean and delivers warming heat. You and your guests will enjoy the ambiance and tranquility of a real fire, without the hassles of burning real wood - no more embers, ash, and soot to clean up.

5. Singly sensational, perfectly paired
Designed to be a standalone piece of functional furniture, or to perfectly pair with Blinde Design's Cube 24 side table to easily transform it into a striking and practical fire table. Use one, use two, use more!

Ground Fixing Brackets
Models come with fixing brackets for permanently locating into a fixed position.

Global Compliance
These models comply with existing standards in the USA, Europe, UK and Australia. O-TL listed to UL 1370, EN 16647 BSI Certified and ACCC Safety Mandate compliant.



Natural



Graphite



Bone

Disclaimer. All product specifications and data are subject to change without notice and believed to be correct at the time of publication. MAD Design Group (MDG), its affiliates, agents, and employees, and all persons acting on its or their behalf (collectively, "MAD Design Group"), disclaim any and all liability for any errors, inaccuracies or incompleteness contained herein or in any other disclosure relating to any product. MDG disclaims any and all liability arising out of the use or application of any product described herein or of any information provided herein to the maximum extent permitted by law. The product specifications do not expand or otherwise modify MDG's terms and conditions of purchase, including but not limited to the warranty expressed therein, which apply to these products. No license, express or implied, by estoppel or otherwise, to any intellectual property rights is granted by this document or by any conduct of MDG. Customers using or selling MDG products not expressly indicated for use in such applications do so entirely at their own risk and agree to fully indemnify MDG for any damages arising or resulting from such use or sale. Please contact authorised personnel from MDG to obtain written terms and conditions regarding products designed for such applications. Images are indicative only.

Sidecar 24 Accessories

Included accessories



Decorative Glass Media

Our decorative Black Glass Charcoal is made from high-quality tempered glass.



Jerry Can with Safety Spout and e-NRG bottle adaptor

Jerry Can allows safe storing/decanting of e-NRG ethanol. e-NRG adaptor connects the Safety Spout to an e-NRG bottle. *e-NRG not available in all countries.*



Lighting Rod & Lighter

The Lighting Rod is designed to safely adjust the slider position on the burner. It is also used for the ignition procedure.



AB8 Efficiency Ring

Placed over the internal burner vent, it serves to increase the efficiency of the burner as well as further stabilise the flame.

Optional accessories



1

Glass Fire Screens

Pair with a glass fire screen, to stabilise the flame in windy conditions.

Designed to accommodate two different glass fire screens:

1. Recessed Square or
2. Raised Round.



2



All Seasons Cover

Take care and protect your investment with our stain and water resistant custom outdoor cover.

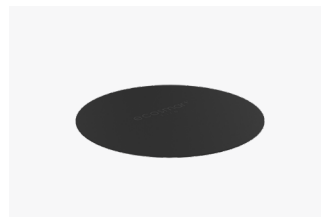

Silicone Burner Cover

Black silicone burner covers protect burners from the elements when not in use.



Glass Cover Plate

Enables fire pit tables to easily be transformed into a usable coffee table surface.

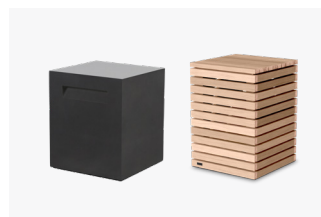

Tank





Tank functions as a side table, or stool. Available in Concrete and Teak finish.

Sidecar 24 Specifications

Made with a smaller footprint to suit smaller spaces. It's equally at home in larger spaces when paired with one, two or more Blinde Design's Cube 24 side tables.

Burner Ventilation and Efficiency*

Compatible Burner	Fuel Capacity	Heats on Average (Indoors)	Thermal Output Net (MAX per burner)	Approx. Burn Time	Minimum Room Size
AB8 (Ethanol)	8 L [2.1 Gal]	Over 60 m ² [645 ft ²]	21.56 MJ/h, 20,433 BTU/h, 5.99 kW	7 - 9 hours	116 m ³ [4,096 ft ³]
With AB8 Efficiency Ring**		Over 30 m ² [322.9 ft ²]	13.9 MJ/h, 12,860 BTU/h, 3.77 kW	9 - 11 hours	

Application ¹	Indoor & Outdoor	
Surround Colours	 Natural ESF.O.SDC.24.NA	 Graphite ESF.O.SDC.24.GH
	 Bone ESF.O.SDC.24.BO	
Burner Colours	 Stainless Steel	 Black
Materials	Fluid Concrete Surround, Grade 304 Stainless Steel Burner, with optional Black Ceramic Coating	
Approx. Weight	49.9 kg [109.9 lb] Weight includes burner & glass charcoal.	
Fuel Type	e-NRG Bioethanol / e-NRG.com	

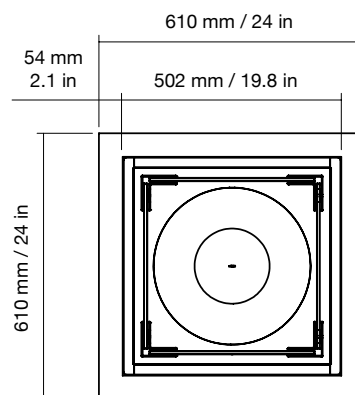
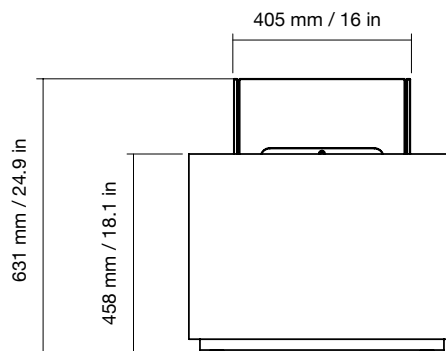

*These values are indicative only and may vary depending on the model purchased, installation, and the seasonal resource used to manufacture e-NRG.

¹For Indoor Use, additional parts are required. Your chosen application is the ONLY application the model can be used in due to modified configuration of the model. Please advise your Sales Representative at time of purchase so that the product can be configured accordingly.

This model complies with existing standards in the USA, Europe, UK and Australia. O-TL listed to UL 1370, EN 16647 BSI Certified and ACCC Safety Mandate compliant. **To comply with EN 16647 the Indoor Safety Tray & included AB8 Burner Efficiency Ring must be installed before operating indoors.

Line drawings show concrete models with the optional Glass Fire Screen.

FOR MORE INFORMATION PLEASE REFERENCE THE CLEARANCE & INSTALLATION MANUAL

Disclaimer. All product specifications and data are subject to change without notice and believed to be correct at the time of publication. MAD Design Group (MDG), its affiliates, agents, and employees, and all persons acting on its or their behalf (collectively, "MAD Design Group"), disclaim any and all liability for any errors, inaccuracies or incompleteness contained herein or in any other disclosure relating to any product. MDG disclaims any and all liability arising out of the use or application of any product described herein or of any information provided herein to the maximum extent permitted by law. The product specifications do not expand or otherwise modify MDG's terms and conditions of purchase, including but not limited to the warranty expressed therein, which apply to these products. No license, express or implied, by estoppel or otherwise, to any intellectual property rights is granted by this document or by any conduct of MDG. Customers using or selling MDG products not expressly indicated for use in such applications do so entirely at their own risk and agree to fully indemnify MDG for any damages arising or resulting from such use or sale. Please contact authorised personnel from MDG to obtain written terms and conditions regarding products designed for such applications. Images are indicative only.