



blinde<sup>TM</sup>

 GOOD DESIGN AWARD<sup>®</sup> WINNER

EUROPEAN PRODUCT DESIGN AWARD

WELCOME TO TIMELESS  
STYLE, ENDURING QUALITY  
AND EASE OF LIVING

# BLINDE DESIGN

## SOPHISTICATED AND ELEGANT DESIGNS THAT ENHANCE YOUR HOME AND YOUR LIFE

Blinde Design tables, outdoor chairs, multi-configuration modular sofas, bar carts and planters cater to our desire for inviting stylish spaces and our love of outdoor living.

With their contemporary design aesthetics and high-quality craftsmanship, every piece in the Blinde Design Collection enhances the look and liveability of any outdoor or indoor environment. In fact, every piece of the Blinde Collection has been designed with comfort and flexibility in mind: within minutes you can adapt your setting to suit your space's layout and the occasion, whether it's a casual meal for two, a family get-together or a celebration with friends.

And as each piece is crafted from strong, durable materials, including natural teak, Sunbrella® fabrics, hi-tech Fluid™ Concrete, and black powder-coated aluminium, they retain their modern, good looks for many years, indoors and out.

Experience the freedom to create indoor and outdoor spaces that enhance your home and your life: Explore the Blinde Design outdoor furniture collection today - or talk to us about creating a unique bespoke design.

CONNECT >  
Modular Sofa

C20 & C26  
Cushions

BLOC L6  
Coffee Table



# COLLECTION

## MODULAR SOFAS 30



Relax

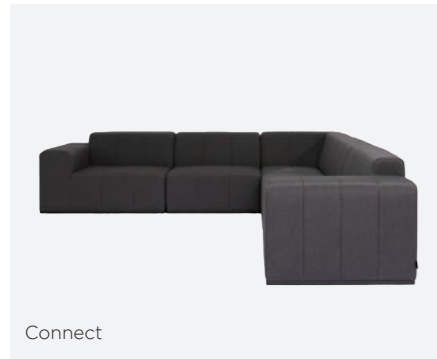

Connect

## CHAIRS 40

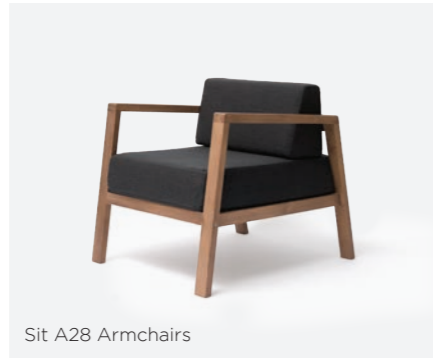

Sit A28 Armchairs



Sit L52 Loveseats

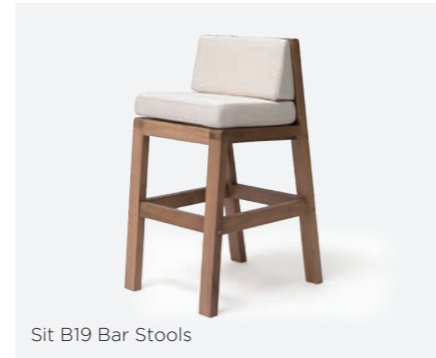

Sit B19 Bar Stools



Sit D24 Dining Chairs

## COFFEE TABLES 46

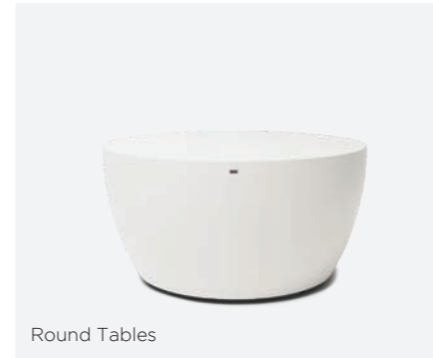

Round Tables



Square Tables



Rectangle Tables

## SIDE TABLE 60



Solo R1

## BAR CART 62



Serve T30

## PLANTERS 66



Stitch

## ACCESSORIES 72



Cushions



< CONNECT  
Modular Sofa

BLOC L6 (left)  
Coffee Table

BLOC L5 (right)  
Coffee Table

SIT A28  
Armchairs

SOLO R1  
Side Table/Stool

Featuring Chaser 38 Fire  
Table (with Glass Cover  
Plate) by [ecosmartfire.com](http://ecosmartfire.com)



^ RELAX  
Modular 5 Sofa Chaise

C20, C26  
Cushions

BLOC L6  
Coffee Table

SIT A28  
Armchair



^ RELAX  
Modular 7 U-Sofa Chaise Sectional

C20, C26  
Cushions

CIRC M1  
Coffee Table

STITCH 25  
Planter



< SIT D24  
Dining Chair (left)

SIT B19  
Bar Stool (middle)

SIT A28  
Armchair (right)



< SIT L52  
Loveseat

CIRC M1  
Coffee Table



^ SIT B19  
Bar Stools

Featuring Gin 90 Bar Fire Table  
by [ecosmartfire.com](http://ecosmartfire.com)



< SOLO R1  
Side Table/Stool



< BLOC L5  
Coffee Table  
  
SOLO R1  
Side Table/Stool

BLOC L5 >  
Coffee Table







< CUBE 24  
Coffee Table

CONNECT  
Modular Sofa

Featuring Sidecar 24 Fire  
Table by [ecosmartfire.com](http://ecosmartfire.com)



^ BLOC L4  
Coffee Table  
  
STITCH 100  
Planter



^ BLOC L1 (front)  
BLOC L2 (middle)  
BLOC L3 (back)  
Coffee Tables  
  
STITCH 100  
Planter



^ CIRC L2  
Coffee Table



^ CIRC L1  
Coffee Table



< NICHE L40  
Coffee Table

∨ NICHE L50  
Coffee Table

CONNECT  
Modular Sofa

< CUBE 24  
Coffee Table

Featuring  
Sidecar 24 Fire Table  
by [ecosmartfire.com](http://ecosmartfire.com)



SOLO R1 >  
Side Table/Stool

SIT A28  
Armchair

SERVE T30  
Bar Cart





^ NICHE L40  
Coffee Table



^ CIRC M2  
Coffee Table  
  
SIT A28  
Armchairs



^ STITCH 100 (left)  
STITCH 75 (right)  
Planters



^ STITCH 50  
Planter



## BLINDE MODEL SPECIFICATIONS

EVERYTHING YOU NEED TO KNOW  
ABOUT DIMENSIONS, COLOUR  
OPTIONS AND STYLES CAN BE FOUND  
ON THE FOLLOWING PAGES.

< RELAX  
Modular Sofa

C26  
Cushions

CIRC M1  
Coffee Table





# MODULAR SOFAS

BLINDE DESIGN MODULAR, OR OUTDOOR SECTIONAL, SOFAS PROVIDE THE ULTIMATE IN STYLE, COMFORT AND FLEXIBILITY. THEY STRIKE THE PERFECT BALANCE BETWEEN SCULPTURED SHAPES WITH MAXIMUM COMFORT AND SUPPORT AND THEY EASILY FIT ANY SETTING, WHETHER IN AN OUTDOOR SPACE OR INSIDE YOUR HOME, OFFICE OR COMMERCIAL AREA.

Our Relax and Connect modular lounge collections mean you can have countless configurations and design styles to seamlessly complement any space. Upholstered in all-weather Sunbrella® Fabric, with a choice of three colour options, they're designed to stand the test of time, even in harsh outdoor environments - and are equally at home indoors.

< RELAX  
Modular Sofa

C20 & C26  
Cushions

BLOC L6  
Coffee Table

# Relax Series



C37 Corner (Left or Right)  
(Canvas fabric)



S37 Single  
(Flanelle fabric)



O37 Ottoman  
(Sooty fabric)

TIMELESS STYLE, DURABLE MATERIALS, SUPREME COMFORT AND VERSATILITY ARE WHAT DEFINE BLINDE DESIGN'S RELAX MODULAR SOFAS.

THEY CAN BE CONFIGURED TO SUIT TO ANY SPACE AND LIFESTYLE, INDOORS AND OUT. WITH A STYLISH LOW-BACK DESIGN CONSTRUCTED FROM A STRONG AND DURABLE POWDER-COATED ALUMINIUM FRAME, WITH COMFORTABLE QUICK DRY FOAM SHELLS UPHOLSTERED IN SOFT BUT STURDY, WEATHER-RESISTANT SUNBRELLA® FABRIC, EACH MODULE IS DESIGNED TO STAND THE TEST OF TIME.

THREE DISTINCT MODULES - THE VERSATILE CORNER (WHICH CAN BE USED LEFT OR RIGHT), SINGLE, AND AN OTTOMAN - ENABLE THE CREATION OF ENDLESS CONFIGURATIONS FOR MODERN OUTDOOR AND INDOOR SPACES.

## RELAX

### Materials

Powder-coated aluminium frame, quick dry memory foam, upholstered in Sunbrella® Fabric

### Sunbrella® Fabric Colours

Flanelle, Sooty, Canvas



### Cushions (Sold Separately)

**C20** 500mm/20" x 500mm/20"

**C26** 650mm/26" x 650mm 26"

### C37 Corner

BLD.MS.RLX.C37

### Dimensions

W 950mm / 37.4"  
D 950mm / 37.4"  
SD 655mm / 25.8"  
H 650mm / 25.6"  
SH 380mm / 15"

### Weight

Approx 13.2kg / 29lbs

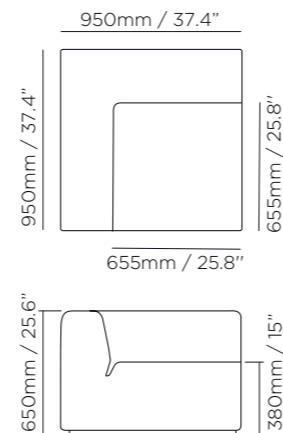

### S37 Single

BLD.MS.RLX.S37

### Dimensions

W 950mm / 37.4"  
D 950mm / 37.4"  
SD 655mm / 25.8"  
H 650mm / 25.6"  
SH 380mm / 15"

### Weight

Approx 12.5kg / 27.5lbs

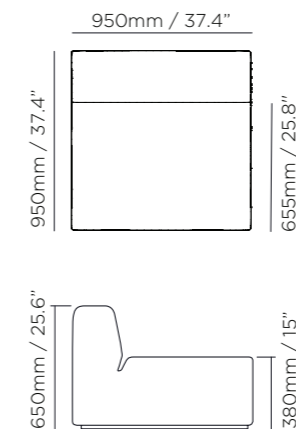

### O37 Ottoman

BLD.MS.RLX.O37

### Dimensions

W 950mm / 37.4"  
D 950mm / 37.4"  
H 380mm / 15"

### Weight

Approx 10.6kg / 23.36lbs

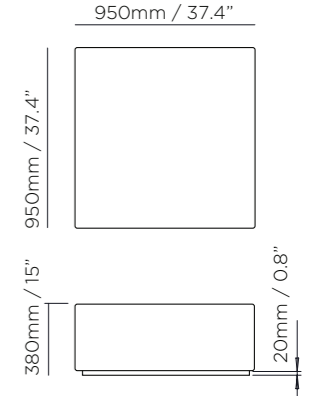

# Relax Configuration Packages

BLINDE RELAX MODULAR SOFAS MEAN YOU HAVE THE FREEDOM TO CREATE A LOUNGE TO SUIT YOUR INDOOR OR OUTDOOR AREA AND LIFESTYLE. CHOOSE ANY NUMBER OF MODULES TO CREATE YOUR OWN LOUNGE OR CHOOSE FROM EIGHT CONFIGURATION PACKAGES THAT OFFER A VARIETY OF LOUNGE DESIGNS, FROM INTIMATE SETTINGS FOR TWO PEOPLE TO LARGE MODULAR CREATIONS FOR ENTERTAINING.

## Modular 3 Sofa BLD.MS.RLX.S3

**Dimensions**  
W 2850mm / 112.2"  
D 950mm / 37.4"  
SD 655mm / 25.8"  
H 650mm / 25.6"  
SH 380mm / 15"



## Modular 4 Sofa BLD.MS.RLX.S4

**Dimensions**  
W 3800mm / 149.6"  
D 950mm / 37.4"  
SD 655mm / 25.8"  
H 650mm / 25.6"  
SH 380mm / 15"



## Modular 5 L-Sectional BLD.MS.RLX.LS5

**Dimensions**  
W 2850mm / 112.2"  
D 2850mm / 112.2"  
SD 655mm / 25.8"  
H 650mm / 25.6"  
SH 380mm / 15"



## Modular 5 Sofa Chaise BLD.MS.RLX.SC5

**Dimensions**  
W 3800mm / 149.6"  
D 1900mm / 74.8"  
SD 655mm / 25.8"  
H 650mm / 25.6"  
SH 380mm / 15"



## Modular 6 L-Sectional BLD.MS.RLX.LS6

**Dimensions**  
W 3800mm / 149.6"  
D 2850mm / 112.2"  
SD 655mm / 25.8"  
H 650mm / 25.6"  
SH 380mm / 15"



## Modular 6 U-Chaise Sectional BLD.MS.RLX.UC6

**Dimensions**  
W 3800mm / 149.6"  
D 1900mm / 74.8"  
SD 655mm / 25.8"  
H 650mm / 25.6"  
SH 380mm / 15"



## Modular 7 U-Sofa Chaise Sectional BLD.MS.RLX.USC7

**Dimensions**  
W 3800mm / 149.6"  
D 2850mm / 112.2"  
SD 655mm / 25.8"  
H 650mm / 25.6"  
SH 380mm / 15"



## Modular 8 U-Sofa Sectional BLD.MS.RLX.US8

**Dimensions**  
W 3800mm / 149.6"  
D 2850mm / 112.2"  
SD 655mm / 25.8"  
H 650mm / 25.6"  
SH 380mm / 15"



Modular components are available individually, allowing you to customise the configuration of your choice.

Modular components are available individually, allowing you to customise the configuration of your choice.

# Connect Series



L50 Left  
(Sooty fabric)



R50 Right  
(Flanelle fabric)



C37 Corner  
(Canvas fabric)



S37 Single  
(Sooty fabric)



O37 Ottoman  
(Flanelle fabric)

BLINDE'S CONNECT MODULES OFFER THE FREEDOM OF CREATING A LOUNGE IN THE SIZE AND SHAPE YOU DESIRE WITH THE ADDED CONVENIENCE OF CLICKING THEM TOGETHER TO KEEP IT IN PLACE.

CONNECT HAS ENDURING STYLE TOO, WITH A TIMELESS LOW-BACK DESIGN, GENTLE CURVES, STRONG POWDER-COATED ALUMINIUM FRAME AND QUICK DRY FOAM COVERED IN WEATHER-RESISTANT SUNBRELLA® FABRIC IN NATURAL HUES. OPTIONAL CUSHIONS, ALSO IN SUNBRELLA® FABRIC, ARE AVAILABLE TO COMPLETE YOUR LOOK.

## CONNECT

### Materials

Powder-coated aluminium frame, quick dry memory foam, upholstered in Sunbrella® Fabric

**Sunbrella® Fabric Colours**  
Flanelle, Sooty, Canvas



### Cushions (Sold Separately)

**C20** 500mm/20" x 500mm/20"

**C26** 650mm/26" x 650mm 26"

### L50 Left

BLD.MS.CON.L50

### R50 Right

BLD.MS.CON.R50

### Dimensions

W 1265mm / 49.9"  
D 950mm / 37.4"  
SD 600mm / 23.6"  
H 780mm / 30.7"  
SH 420mm / 16.5"

### Weight

Approx 17.5kg / 38.5lbs

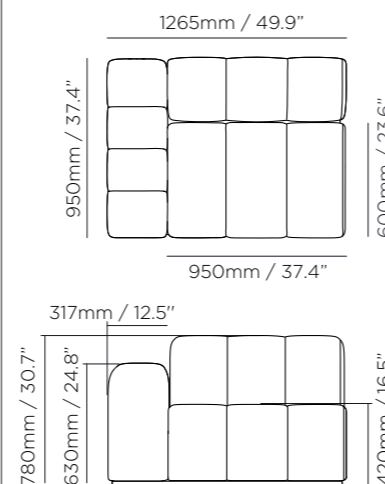

### C37 Corner

BLD.MS.CON.C37

### Dimensions

W 950mm / 37.4"  
D 950mm / 37.4"  
SD 600mm / 23.6"  
H 780mm / 30.7"  
SH 420mm / 16.5"

### Weight

Approx 15.1kg / 33.2lbs

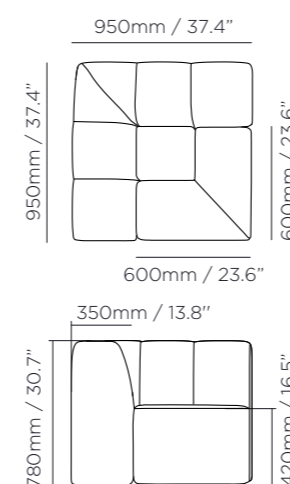

### S37 Single

BLD.MS.CON.S37

### Dimensions

W 950mm / 37.4"  
D 950mm / 37.4"  
SD 600mm / 23.6"  
H 780mm / 30.7"  
SH 420mm / 16.5"

### Weight

Approx 13.6kg / 29.9lbs

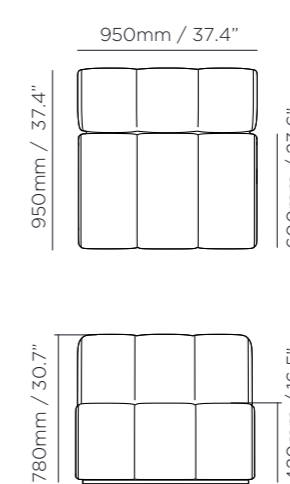

### O37 Ottoman

BLD.MS.CON.O37

### Dimensions

L 950mm / 37.4"  
W 950mm / 37.4"  
H 420mm / 16.5"

### Weight

Approx 10.9kg / 24lbs

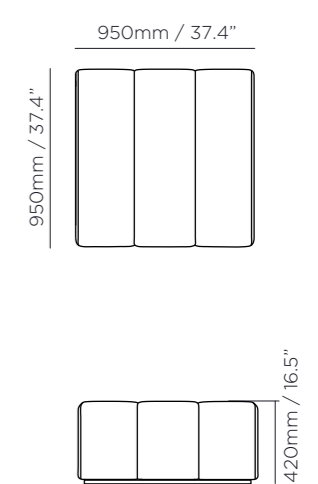

# Connect Configuration Packages

WITH EIGHT CONFIGURATION PACKAGES TO CHOOSE FROM AND THE OPTION OF CREATING YOUR OWN SHAPE AND SIZE, WITH CONNECT YOU CAN CREATE THE PERFECT MODULAR SOFA, FOR YOUR INDOOR OR OUTDOOR SPACE AND LIFESTYLE. EASY TO MOVE AND CONNECT TOGETHER, YOU CAN ADJUST THE COMBINATION AND CONFIGURATION OF YOUR MODULES FOR EACH OCCASION OR FOR A FRESH NEW LOOK.

## Modular 3 Sofa BLD.MS.CON.S3

**Dimensions**  
W 3485mm / 137.2"  
D 950mm / 37.4"  
SD 600mm / 23.6"  
H 780mm / 30.7"  
SH 420mm / 16.5"



## Modular 4 Sofa BLD.MS.CON.S4

**Dimensions**  
W 4435mm / 174.6"  
D 950mm / 37.4"  
SD 600mm / 23.6"  
H 780mm / 30.7"  
SH 420mm / 16.5"



## Modular 6 L-Sectional BLD.MS.CON.LS6

**Dimensions**  
W 4115mm / 162.1"  
D 3165mm / 124.7"  
SD 600mm / 23.6"  
H 780mm / 30.7"  
SH 420mm / 16.5"



## Modular 6 U-Chaise Sectional BLD.MS.CON.UC6

**Dimensions**  
W 4435mm / 174.6"  
D 1900mm / 74.8"  
SD 600mm / 23.6"  
H 780mm / 30.7"  
SH 420mm / 16.5"



## Modular 5 L-Sectional BLD.MS.CON.LS5

**Dimensions**  
W 3165mm / 124.7"  
D 3165mm / 124.7"  
SD 600mm / 23.6"  
H 780mm / 30.7"  
SH 420mm / 16.5"



## Modular 5 Sofa Chaise BLD.MS.CON.SC5

**Dimensions**  
W 4435mm / 174.6"  
D 1900mm / 74.8"  
SD 600mm / 23.6"  
H 780mm / 30.7"  
SH 420mm / 16.5"



## Modular 7 U-Sofa Chaise Sectional BLD.MS.CON.USC7

**Dimensions**  
W 4115mm / 162.1"  
D 3165mm / 124.7"  
SD 600mm / 23.6"  
H 780mm / 30.7"  
SH 420mm / 16.5"



## Modular 8 U-Sofa Sectional BLD.MS.CON.US8

**Dimensions**  
W 3800mm / 149.6"  
D 3165mm / 124.7"  
SD 600mm / 23.6"  
H 780mm / 30.7"  
SH 420mm / 16.5"



Modular components are available individually, allowing you to customise the configuration of your choice.

Modular components are available individually, allowing you to customise the configuration of your choice.



# CHAIRS

DESIGNED TO BE COMFORTABLE, FUNCTIONAL AND STYLISH, BLINDE DESIGN'S COLLECTION OF OUTDOOR CHAIRS CREATE AN EYE-CATCHING STATEMENT IN ANY SPACE, OUTDOORS AND IN. AND WITH DURABLE AND COMFORTABLE INDIVIDUAL (OR ACCENT) CHAIRS, ARMCHAIRS, LOVESEATS AND BAR/COUNTER STOOLS, WE HAVE EVERY OCCASION COVERED.

The wooden chairs in the Sit Collection feature sleek, clean-lined frames crafted from premium teak, which is naturally moisture, light and heat resistant - and the strongest hardwood on the market. Upholstered in high quality, weather-resistant Sunbrella® fabric, Blinde Design outdoor chairs are ideal for open-air environments and look good, year after year.

< SIT A28  
Armchair

SOLO R1  
Side Table/Stool

# Sit Series



Sit A28 Armchair  
(Canvas fabric)



Sit D24 Dining  
(Sooty fabric)



Sit B19 Bar Stool  
(Flanelle fabric)

WITH THEIR CLEAN LINES, CONTEMPORARY SHAPES AND ENDURING MATERIALS, BLINDE DESIGN SIT COLLECTION OF OUTDOOR CHAIRS HAVE BEEN CREATED WITH A MYRIAD OF ALFRESCO AND INDOOR SETTINGS IN MIND.

AVAILABLE IN FOUR CHAIR TYPES - ARMCHAIR, DINING, BAR STOOL AND LOVESEAT (2-SEATER SOFA), THE CHAIRS ALL PROVIDE SUPERIOR SEATING COMFORT. FRAMED IN TEAK WOOD WITH MOULDED FOAM CUSHIONING UPHOLSTERED IN SUNBRELLA® FABRIC - THE SIT COLLECTION OF CHAIRS STRIKE THE PERFECT BALANCE BETWEEN COMFORT AND FUNCTIONALITY.

## SIT A28

BLD.C.SIT.A28

### Dimensions

W 720mm / 28.3"  
D 875mm / 34.4"  
H 750mm / 29.5"  
SD 500mm / 19.6"  
SH 450mm / 17.7"

### Weight

Approx 13.5kg / 29.8lbs

### Material/Finish

Teak Wood



### Fill

Quick dry memory foam

### Upholstery

100% Sunbrella® Fabric

### Sunbrella® Fabric Colours

Flanelle, Sooty, Canvas

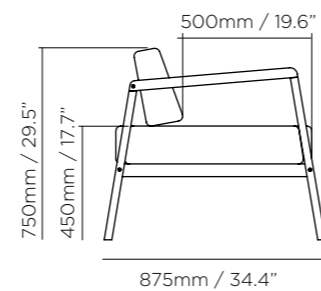
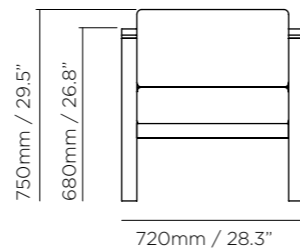

## SIT D24

BLD.C.SIT.D24

### Dimensions

W 610mm / 24"  
D 760mm / 29.9"  
SD 405mm / 16"  
H 780mm / 30.7"  
SH 455mm / 18"

### Weight

Approx 11.2kg / 24.7lbs

### Material/Finish

Teak Wood



### Fill

Quick dry memory foam

### Upholstery

100% Sunbrella® Fabric

### Sunbrella® Fabric Colours

Flanelle, Sooty, Canvas

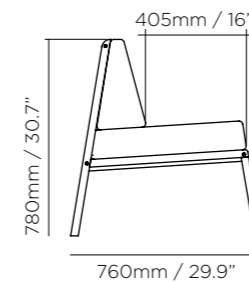
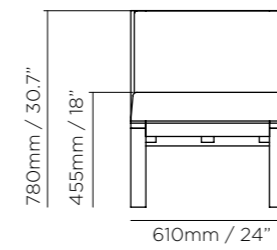

## SIT B19

BLD.2.C.SIT.B19

### Dimensions

W 475mm / 18.6"  
D 745mm / 29.3"  
SD 550mm / 21.6"  
H 940mm / 37"  
SH 725mm / 28.5"

### Weight

Approx 10.7kg / 23.6lbs

### Material/Finish

Teak Wood



### Fill

Quick dry memory foam

### Upholstery

100% Sunbrella® Fabric

### Sunbrella® Fabric Colours

Flanelle, Sooty, Canvas

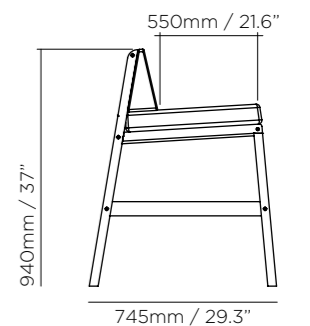
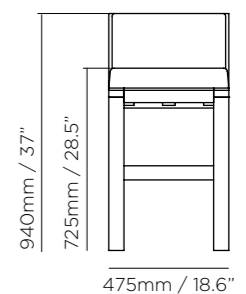

# Sit Series



SIT L52 Loveseat  
(Flanelle fabric)

**SIT L52**  
BLD.C.SIT.L52

**Dimensions**  
W 1320mm / 52"  
D 875mm / 34.4"  
SD 500mm / 19.6"  
H 750mm / 29.5"  
SH 450mm / 17.7"

**Weight**  
Approx 20kg / 44.1lbs

**Material/Finish**  
Teak Wood



**Fill**  
Quick dry memory foam

**Upholstery**  
100% Sunbrella® Acrylic

**Sunbrella® Fabric Colours**  
Flanelle, Sooty, Canvas

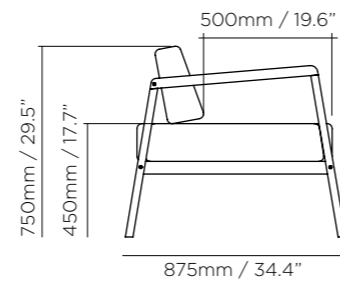
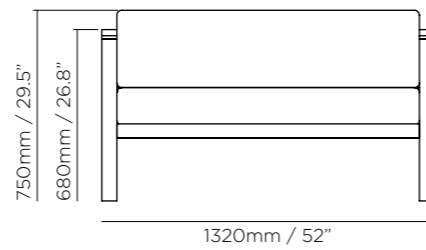

Sit D24 Dining  
(Canvas fabric)



Sit A28 Armchair  
(Sooty fabric)



Sit B19 Bar Stool  
(Flanelle fabric)





## TABLES

WITH THEIR CLEAN LINES AND CONTEMPORARY AESTHETIC, BLINDE DESIGN TABLES MAKE A STYLE STATEMENT IN ANY OUTDOOR OR INDOOR SPACE. BLINDE TABLES STRIKE THE PERFECT BALANCE BETWEEN VERSATILITY, DURABILITY AND FUNCTIONALITY, AND WITH THEIR STRIKING CONTOURED SCULPTURAL SHAPES AND CONSISTENT COLOUR, THEY ENHANCE ANY ARCHITECTURAL ENVIRONMENT.

Our Blinde concrete coffee and side tables are handcrafted using Fluid™ Concrete Technology, which gives them a smooth finish and a durable and robust composition. Choose from two sizes - low and medium size - and from three on-trend colours - Natural, Graphite and Bone - that complement any alfresco and interior space.

< CIRC M1  
Coffee Table

SOLO R1  
Side Table/Stool

# Circ Series



Bone



Graphite



Natural



Natural



Bone



Graphite

BOLD AND STYLISH, BLINDE DESIGN'S LOW-SET, ROUND-SHAPED CIRC L1 CONCRETE TABLE FEATURES CLASSIC STRAIGHT SIDES AND DEFINED EDGES. BUILT FOR HIGH PERFORMANCE IN ALL WEATHER CONDITIONS, THIS CIRCULAR OUTDOOR COFFEE TABLE IS AVAILABLE IN THREE ORGANIC COLOURS TO COMPLEMENT YOUR INDOOR OR OUTDOOR SETTING.

**CIRC L1**  
BLD.T.CIR.L1

**Dimensions**  
L 1000mm / 39.4"  
W 1000mm / 39.4"  
H 340mm / 13.3"

**Weight**  
Approx. 35.5kg / 78.1lbs

**Material**  
Fluid™ Concrete Technology

**Fluid™ Colours**  
Graphite, Natural and Bone

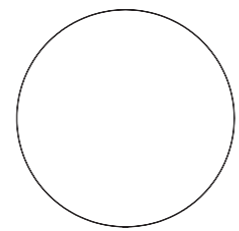

1000mm / 39.4"



340mm / 13.3"

THE ORGANIC, CIRCULAR CURVES AND SOFT EDGES OF THE ROUND BLINDE DESIGN CIRC M1 MID-SIZED CONCRETE TABLE GIVES ANY SETTING, INDOORS OR OUT, SOPHISTICATED ELEGANCE. CHOOSE FROM THREE COLOURS - GRAPHITE, NATURAL AND BONE - TO ENHANCE YOUR NATURAL OR ARCHITECTURAL SPACE.

**CIRC M1**  
BLD.T.CIR.M1

**Dimensions**  
L 770mm / 30.4"  
W 770mm / 30.4"  
H 400mm / 15.8"

**Weight**  
Approx. 19kg / 41.8lbs

**Material**  
Fluid™ Concrete Technology

**Fluid™ Colours**  
Graphite, Natural and Bone

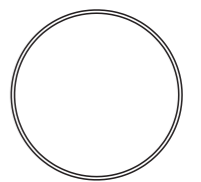

770mm / 30.4"



400mm / 15.8"

# Circ Series



Natural



Bone



Graphite



Natural



Bone



Graphite

THE LOW-SET BLINDE DESIGN CIRC L2 ROUND CONCRETE TABLE BOASTS GENTLE, ORGANIC CURVES AND SOFT EDGES, TO COMPLETE YOUR OUTDOOR SETTING. HANDCRAFTED FROM FLUID™ CONCRETE, THE SMOOTH-SURFACED CIRC L2 IS EQUALLY SUITED FOR INDOOR USE.

## CIRC L2

BLD.T.CIR.L2

### Dimensions

L 760mm / 30"  
W 760mm / 30"  
H 350mm / 13.8"

### Weight

Approx. 23.5kg / 51.7lbs

### Material

Fluid™ Concrete Technology

### Fluid™ Colours

Graphite, Natural and Bone

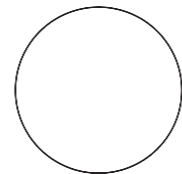

760mm / 30"



350mm / 13.8"

THE LARGEST AND TALLEST OF THE ROUND, CURVED-SIDED CONCRETE TABLES, THE BLINDE DESIGN CIRC M2 WILL ADD PANACHE TO YOUR OUTDOOR AND INTERIOR SPACES. CRAFTED USING LIGHTWEIGHT FLUID™ CONCRETE TECHNOLOGY, THIS OUTDOOR/INDOOR COFFEE TABLE COMBINES FUNCTION, FORM AND DURABILITY.

## CIRC M2

BLD.T.CIR.M2

### Dimensions

L 1000mm / 39.4"  
W 1000mm / 39.4"  
H 505mm / 19.8"

### Weight

Approx. 44.5kg / 97.9lbs

### Material

Fluid™ Concrete Technology

### Fluid™ Colours

Graphite, Natural and Bone

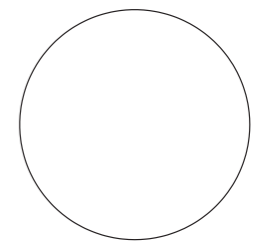

1000mm / 39.4"



505mm / 19.8"

# Niche Series



Natural



Bone



Graphite



Bone



Graphite



Natural

SIMPLE BUT IMPACTFUL CONTEMPORARY DESIGN PROVIDES A SOPHISTICATED WATERFALL-STYLE COFFEE TABLE TO ADD PANACHE TO YOUR INDOOR OR OUTDOOR LIVING SPACES.

THE SMALLEST IN THE NICHE SERIES, THE NICHE L40 IS FASHIONED OUT OF HIGH QUALITY, DURABLE FLUID™ CONCRETE. BLENDING LINEAR COMPONENTS WITH ITS DISTINCTIVE WATERFALL DESIGN,

**NICHE L40**  
BLD.T.NCH.L40

**Dimensions**  
L 1000mm / 39.4"  
W 1000mm / 39.4"  
H 340mm / 13.3"

**Weight**  
55kg / 121lbs

**Material**  
Fluid™ Concrete Technology

**Fluid™ Colours**  
Graphite, Natural and Bone



1000mm / 39.4"

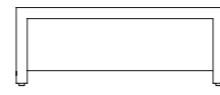

1000mm / 39.4"

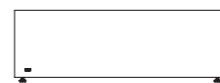

340mm / 13.3"

MINIMAL YET CONTEMPORARY, THE NICHE L50 COFFEE TABLE - THE LARGEST SIZE IN THE NICHE SERIES - IS PERFECT FOR ENHANCING THE LOOK OF ANY CHIC MEDIUM TO LARGE LIVING ROOM OR OUTDOOR LOUNGE SETTING.

IT BLENDS LINEAR COMPONENTS WITH A DISTINCTIVE WATERFALL DESIGN TO CREATE A STRIKING PIECE OF FURNITURE. ALSO INCORPORATED IS A CLEVERLY DESIGNED VISUAL NEGATIVE SPACE SHELF, WHICH IS PERFECT FOR STORING CUSHIONS, DECORATIVE TIMBER LOGS, OR BOOKS.

**NICHE L50**  
BLD.T.NCH.L50

**Dimensions**  
L 1270mm / 50"  
W 760mm / 30"  
H 285mm / 11.1"

**Weight**  
66kg / 145.2lbs

**Material**  
Fluid™ Concrete Technology

**Fluid™ Colours**  
Graphite, Natural and Bone



1270mm / 50"



760mm / 30"

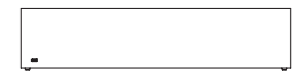

285mm / 11.1"

# Bloc Series



Natural



Graphite



Bone

BLINDE DESIGN'S RECTANGULAR CONCRETE TABLE MODELS MAKE A BOLD AND MODERN STATEMENT IN ANY OF TODAY'S OUTDOOR - AND INDOOR - LIVING AND ENTERTAINING SPACES. WITH THREE MODELS - L3, L2 AND L1 - IN DIFFERENT SIZES, VERSATILITY IS KEYNOTE.

POSITION THEM ALONGSIDE A WALL, USE THEM TO DIVIDE A SPACE, OR PLACE THEM IN FRONT OF A SOFA, THEY ENSURE THE PERFECT SETTING - ESPECIALLY WHEN PAIRED WITH BLINDE DESIGN MODULAR SOFAS OR CHAIRS. MADE FROM FLUID™ CONCRETE, THEY'RE BUILT FOR HIGH PERFORMANCE IN ALL WEATHER CONDITIONS.

## BLOC L3

BLD.T.BLC.L3

### Dimensions

L 1700mm / 67"  
W 500mm / 19.7"  
H 370mm / 14.5"

### Weight

Approx. 66kg / 145.2lbs

### Material

Fluid™ Concrete Technology

### Fluid™ Colours

Graphite, Natural and Bone

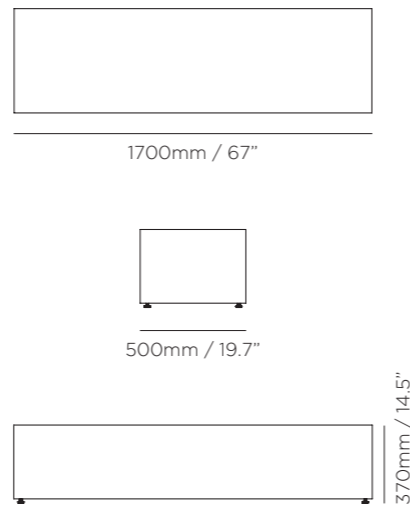

## BLOC L2

BLD.T.BLC.L2

### Dimensions

L 1200mm / 47"  
W 400mm / 15.7"  
H 320mm / 12.6"

### Weight

33kg / 72.6lbs

### Material

Fluid™ Concrete Technology

### Fluid™ Colours

Graphite, Natural, Bone

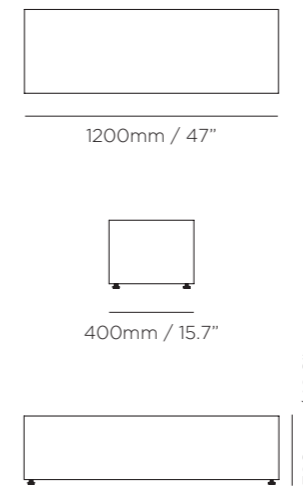

## BLOC L1

BLD.T.BLC.L1

### Dimensions

L 1000mm / 39.4"  
W 400mm / 15.7"  
H 270mm / 10.7"

### Weight

Approx. 25.5kg / 56.1lbs

### Material

Fluid™ Concrete Technology

### Fluid™ Colours

Graphite, Natural and Bone

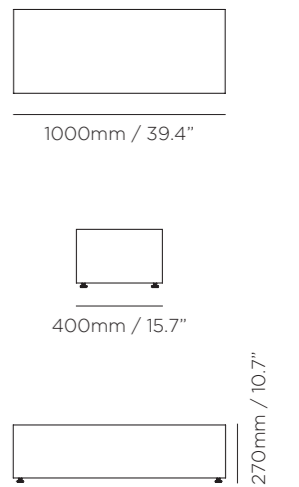

# Bloc Series



Natural



Bone



Graphite



Graphite

THE SQUARE BLINDE DESIGN BLOC L4 IS A CLEAN-LINED, CONTEMPORARY CONCRETE COFFEE TABLE, CRAFTED FROM FLUID™ CONCRETE, WHICH IS WEATHER, UV AND STAIN RESISTANT.

THIS CLASSIC MODEL SITS ON DISCRETELY DESIGNED LEVELLING FEET AND CAN BE PAIRED WITH A MYRIAD OF SOFA TYPES - WHETHER A SMALLER LOVESEAT OR LONGER-STYLE MODULAR SOFA.

**BLOC L4**  
BLD.T.BLC.L4

**Dimensions**  
L 1000mm / 39.4"  
W 1000mm / 39.4"  
H 340mm / 13.3"

**Weight**  
Approx. 36.9kg / 81.2lbs

**Material**  
Fluid™ Concrete Technology

**Fluid™ Colours**  
Graphite, Natural and Bone



1000mm / 39.4"



1000mm / 39.4"



340mm / 13.3"

THE BLINDE DESIGN RECTANGULAR-SHAPED BLOC L5 COMBINES STYLE AND UTILITY, WITH CLASSIC, CLEAN LINES AND STRONG AND DURABLE CONSTRUCTION THAT PROVIDE A CHIC AND FUNCTIONAL SOLUTION FOR A MYRIAD OF OUTDOOR SPACES AND INDOOR ROOMS.

**BLOC L5**  
BLD.T.BLC.L5

**Dimensions**  
L 1650mm / 65"  
W 1000mm / 39.4"  
H 340mm / 13.3"

**Weight**  
Approx. 83kg / 182.6lbs

**Material**  
Fluid™ Concrete Technology

**Fluid™ Colours**  
Graphite, Natural and Bone

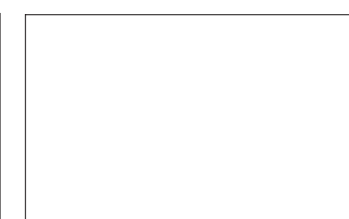

1650mm / 65"



1000mm / 39.4"

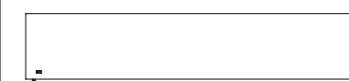

340mm / 13.3"

# Bloc Series



FEATURING A DISCRETE SHADOW LINE BASE, BLINDE DESIGN'S RECTANGULAR-SHAPED BLOC L6 CONCRETE TABLE PROVIDES ELEGANCE, WITH THE ELEVATED DESIGN ENHANCING ITS FUNCTIONALITY. EQUALLY AT HOME OUTDOORS AND IN, THE BLOC L6'S CLEAN LINES AND NATURAL PALETTE COMPLEMENT ANY NATURAL OR ARCHITECTURAL ENVIRONMENT.

**BLOC L6**  
BLD.T.BLC.L6

**Dimensions**  
L 1270mm / 50"  
W 760mm / 30"  
H 295mm / 11.7"

**Weight**  
Approx. 42kg / 92.4lbs

**Material**  
Fluid™ Concrete Technology

**Fluid™ Colours**  
Graphite, Natural and Bone

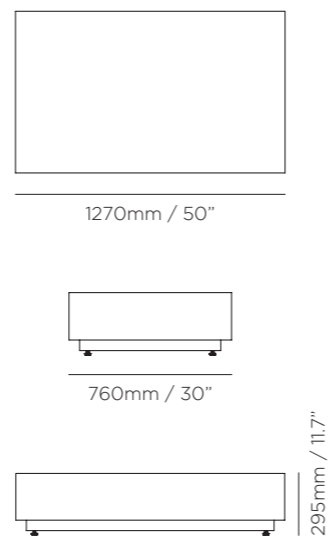

# Cube Series



CLEVERLY CRAFTED FLUID™ CONCRETE SIDE OR COFFEE TABLE DESIGNED TO BE A STANDALONE PIECE OF FUNCTIONAL FURNITURE, OR TO PERFECTLY PAIR WITH ECOSMART'S SIDECAR 24 FIRE PIT TABLE TO EASILY TRANSFORM IT INTO A STRIKING AND PRACTICAL FIRE TABLE. USE ONE, USE TWO, USE MORE! IT'S THAT VERSATILE TO RECONFIGURE DEPENDING ON THE OCCASION AND SETTING.

CLEAN-LINED SQUARE DESIGN WITH AN UNOBTRUSIVE 'KICK' DETAIL, CREATING A SHADOW LINE THAT GIVES A VISUAL EFFECT OF 'FLOATING'. WEATHER RESISTANT AND DURABLE, IT'S IDEAL FOR ANY INDOOR OR OUTDOOR SETTING. AVAILABLE IN THREE TIMELESS HUES: NATURAL, GRAPHITE, BONE.

**CUBE 24**  
BLD.T.CUB.24

**Dimensions**  
L 610mm / 24"  
W 610mm / 24"  
H 460mm / 18.1"

**Weight (approx)**  
34kg / 74.8lbs

**Material**  
Fluid™ Concrete Technology

**Fluid™ Colours**  
Graphite, Natural and Bone

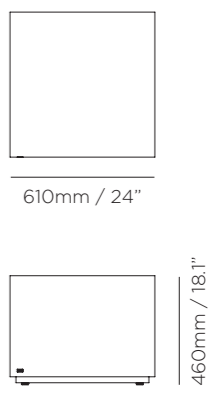

# Solo Series



Bone



Graphite



Natural

SOLO R1 IS A VERSATILE PIECE OF FURNITURE, DOUBLING AS EITHER A STAND-ALONE SIDE TABLE OR TRENDY STOOL. MANUFACTURED FROM FLUID CONCRETE TECHNOLOGY, SOLO R1 IS LIGHT FOR EASY MOBILITY, BUT HEAVY ENOUGH FOR COMMERCIAL USE. SOLO R1 FEATURES HEIGHT ADJUSTABLE ARTICULATING FEET FOR STABILITY ON NEARLY ANY SURFACE.

**SOLO R1**  
BLD.T.SOL.R1

**Dimensions**

L 305mm / 12"  
W 305mm / 12"  
H 470mm / 18.4"

**Weight**

Approx. 7.5kg / 16.5lbs

**Material**

Fluid™ Concrete Technology

**Fluid™ Colours**

Graphite, Natural and Bone

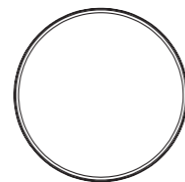

305mm / 12"

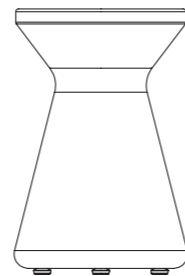

470mm / 18.4"







# BAR CART

BLINDE DESIGN BAR CARTS PROVIDE THE PERFECT SOLUTION FOR ALL YOUR ENTERTAINING NEEDS. PRACTICAL YET CONTEMPORARY DESIGNS COMBINE TO COMPLEMENT ANY SETTING, PROVIDING A MUST-HAVE FOR ENTERTAINING AT HOME AND STORING YOUR BAR ESSENTIALS.

With its geometric design and sleek lines, Blinde Design's Serve T30 bar cart is the perfect combination of form and function. A stylish and sturdy outdoor serving cart - or perhaps a mobile cocktail bar - it's crafted from naturally weather-resistant teak wood. The serving cart's two generous serving levels enable drinks and food to be smoothly transported from the kitchen or bar to anywhere in the home and garden.

< SERVE T30  
Bar Cart

# Serve Series



T30  
(Side View)



T30  
(Front View)



T30  
(Back View)

THE BLINDE SERVE T30 BAR CART IS DESIGNED WITH SLEEK, CONTIGUOUS LINES TO PROVIDE A STYLISH AND FUNCTIONAL ADDITION TO ANY ENTERTAINING SPACE. WITH TWO SHELVING LEVELS, THERE IS PLENTY OF ROOM FOR YOUR FAVOURITE SELECTION OF WINES, SPIRITS AND ACCESSORIES, OR FOR TRANSPORTING FOOD TO ANYWHERE IN YOUR HOME AND ALFRESCO SPACES.

CRAFTED FROM NATURALLY WEATHER-RESISTANT TEAK WOOD. THE PERFECT COMBINATION OF STYLE, UTILITY AND CONVENIENCE.

## SERVE T30

BLD.BC.SRV.T30

### Dimensions

L 865mm / 34.1"  
W 575mm / 22.7"  
H 765mm / 30.2"

### Weight

Approx. 18.5kg / 40.7lbs

### Material/Finish

Teak Wood

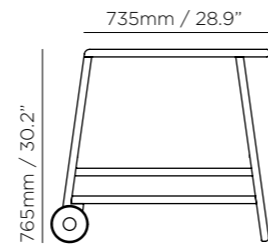
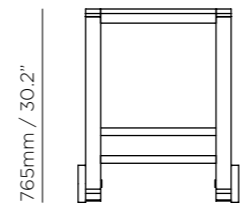



# PLANTERS

ELEGANT AND TIMELESS, BLINDE DESIGN CONCRETE PLANTERS ARE A CHIC ADDITION TO YOUR OUTDOOR OR INDOOR SPACE. WITH THEIR BOLD SCULPTURAL STYLE, THESE INDOOR AND OUTDOOR PLANT POTS ARE AN ESSENTIAL ADDITION FOR SHOWCASING FRESH OR FAUX POTTED PLANTS.

Blinde Design's collection of concrete planters are designed to make a design statement while providing a practical solution. Crafted from Fluid™ Concrete in three natural hues, these durable outdoor/indoor plant pots look stunning as a singular feature; as a set they look spectacular. Available in a range of sizes, our collection of robust, modern planters will complement a range of architectural styles.

< STITCH 125  
Planter



# Stitch Series



Graphite with Yellow Stitch



Bone with White Stitch



Natural with Black Stitch

THE AWARD-WINNING BLINDE DESIGN STITCH PLANTERS ARE A UNIQUE TWIST ON CONTEMPORARY PLANT POT STYLES. WITH THEIR SCULPTURAL SHAPE AND STITCHED EMBELLISHMENT, THEY ARE DESIGNED TO ADD VISUAL INTEREST TO OR TRANSFORM THE LOOK OF YOUR OUTDOOR AREA OR INDOOR ROOMS, WHETHER HOME OR WORKPLACE.

CRAFTED FROM SMOOTH FLUID™ CONCRETE, A RELATIVELY LIGHTWEIGHT AND INCREDIBLY STRONG MATERIAL, STITCH PLANTERS ARE ENHANCED WITH A UNIQUE LARGE-FORMAT DECORATIVE ROPE, OR STITCH, ON THE SEAMS, GIVING THEM AN ALMOST LEATHER-LIKE AESTHETIC.

STITCH IS AVAILABLE IN FOUR SIZES TO SUIT ALL LOCATIONS AND CHOICE OF PLANTS, AND COME IN THREE COLOURS WITH THE CHOICE OF SIX STITCHING COLOURS ENABLING YOU TO PERSONALISE THE LOOK OF YOUR SPACE.

## STITCH 125 BLD.P.STI.125

### Dimensions

L 1220mm / 48"  
W 1045mm / 41.3"  
H 750mm / 29.5"

### Pot Opening Dimensions

L 1110mm / 43.8"  
W 740mm / 29.1"

### Maximum Internal Pot Size

Ø 640mm / 25.2"  
H 550mm / 21.7"

### Weight

Approx. 50.7kg / 111.5lbs

### Materials

Fluid™ Concrete Technology  
Decorative Rope

### Fluid™ Concrete Pot Colours

Graphite, Natural and Bone



### Stitch Rope Colours

Yellow, Grey, Black, White, Orange and Red

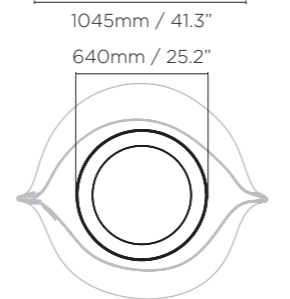
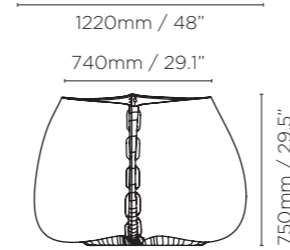
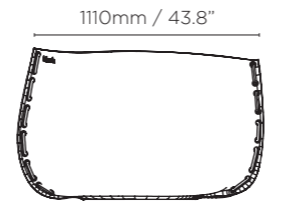

\*Internal pot not included

## STITCH 100 BLD.P.STI.100

### Dimensions

L 1115mm / 43.9"  
W 960mm / 37.9"  
H 685mm / 27"

### Pot Opening Dimensions

L 1020mm / 40.1"  
W 675mm / 26.6"

### Maximum Internal Pot Size

Ø 605mm / 23.8"  
H 460mm / 18"

### Weight

Approx. 37.7kg / 82.9lbs

### Materials

Fluid™ Concrete Technology  
Decorative Rope

### Fluid™ Concrete Pot Colours

Graphite, Natural and Bone



### Stitch Rope Colours

Yellow, Grey, Black, White, Orange and Red

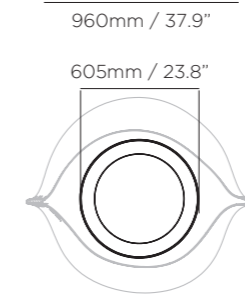
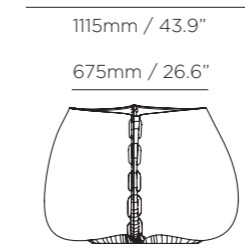
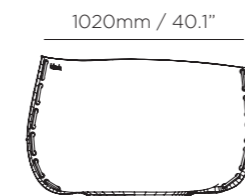

\*Internal pot not included

## STITCH 75 BLD.P.STI.75

### Dimensions

L 970mm / 38.2"  
W 840mm / 33"  
H 600mm / 23.5"

### Pot Opening Dimensions

L 885mm / 34.9"  
W 585mm / 23.1"

### Maximum Internal Pot Size

Ø 555mm / 21.8"  
H 400mm / 15.7"

### Weight

Approx. 33.9kg / 74.6lbs

### Materials

Fluid™ Concrete Technology  
Decorative Rope

### Fluid™ Concrete Pot Colours

Graphite, Natural and Bone



### Stitch Rope Colours

Yellow, Grey, Black, White, Orange and Red

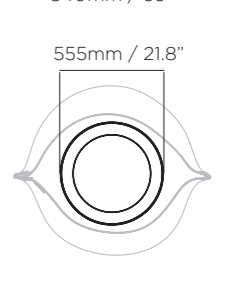
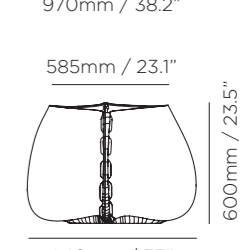
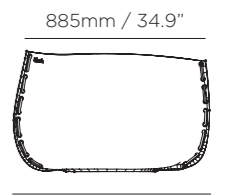
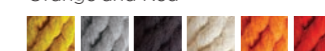

\*Internal pot not included

# Stitch Series



Graphite with Red Stitch



Bone with Yellow Stitch

## STITCH 50

BLD.P.STI.50

**Dimensions**  
 L 915mm / 36"  
 W 785mm / 31"  
 H 565mm / 22.2"

**Pot Opening Dimensions**  
 L 835mm / 32.9"  
 W 555mm / 21.8"

**Maximum Internal Pot Size**  
 Ø 500mm / 16.6"  
 H 380mm / 15"

**Weight**  
 Approx. 31.3kg / 68.9lbs

**Materials**  
 Fluid™ Concrete Technology  
 Decorative Rope

**Fluid™ Concrete Pot Colours**  
 Graphite, Natural and Bone



**Stitch Rope Colours**  
 Yellow, Grey, Black, White, Orange and Red



\*Internal pot not included

835mm / 32.9"

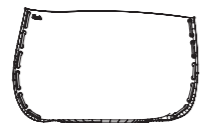

915mm / 36"

555mm / 21.8"



785mm / 31"

500mm / 16.6"

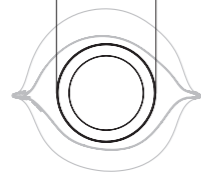

## STITCH 25

BLD.P.STI.25

**Dimensions**  
 L 675mm / 26.7"  
 W 585mm / 23"  
 H 415mm / 16.4"

**Pot Opening Dimensions**  
 L 615mm / 24.3"  
 W 410mm / 16.1"

**Maximum Internal Pot Size**  
 Ø 355mm / 14"  
 H 280mm / 11"

**Weight**  
 Approx. 16kg / 35.2lbs

**Materials**  
 Fluid™ Concrete Technology  
 Decorative Rope

**Fluid™ Concrete Pot Colours**  
 Graphite, Natural and Bone



**Stitch Rope Colours**  
 Yellow, Grey, Black, White, Orange and Red



\*Internal pot not included

615mm / 24.3"

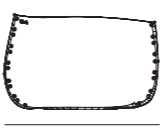

675mm / 26.7"

410mm / 16.1"



585mm / 23"

355mm / 14"



# Stitch Colour Combinations

## Graphite



Yellow Stitch



Grey Stitch



Black Stitch



White Stitch



Orange Stitch

## Natural



Yellow Stitch



Grey Stitch



Black Stitch



White Stitch



Orange Stitch

## Bone



Yellow Stitch



Grey Stitch



Black Stitch



White Stitch



Orange Stitch

# Cushions



BLINDE DESIGN'S OPTIONAL CUSHIONS ARE DESIGNED TO PROVIDE THE FINISHING TOUCH TO YOUR OUTDOOR SETTING. COVERED IN HIGH PERFORMANCE WEATHER- AND STAIN-RESISTANT SUNBRELLA® FABRIC AND FILLED WITH A HIGHLY DURABLE FOAM THAT'S BREATHABLE AND QUICK TO DRY, THEY'RE THE PERFECT SOLUTION FOR OUTDOOR LIVING.

THERE ARE TWO SIZES TO CHOOSE FROM, EACH IN A CHOICE OF THREE NEUTRAL SHADES - THE SAME AS OUR CHAIRS AND MODULAR SOFAS, ENABLING YOU TO CREATE A COMPLEMENTARY OR CONTRASTING LOOK.

## C20 CUSHION

BLD.A.CSH.C20

**Dimensions**  
 L 500mm / 20"  
 W 500mm / 20"  
 D 250mm / 10"

## C26 CUSHION

BLD.A.CSH.C26

**Dimensions**  
 L 650mm / 26"  
 W 650mm / 26"  
 D 300mm / 12"

**Cover**  
 100% Sunbrella® Acrylic

**Fill**  
 Quick dry memory foam

**Sunbrella® Fabric Colours**  
 Flanelle, Sooty, Canvas

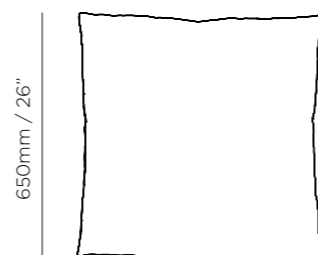

# Fluid™ Concrete Technology



**BLINDE CONCRETE TABLES AND PLANTERS ARE HANDCRAFTED USING ENVIRONMENTALLY FRIENDLY MATERIALS AND FLUID™ CONCRETE TECHNOLOGY, A SOPHISTICATED AND STREAMLINED SYSTEM THAT CREATES EXCEPTIONALLY STRONG, DURABLE AND RELATIVELY LIGHTWEIGHT CONCRETE PRODUCTS, EVERY TIME.**

Each concrete table and planter pot has a smooth and seamless surface that has consistent colour and is resistant to moisture, stains, heat and UV rays - making them highly suitable for the outdoors and entertaining, indoors and out. And importantly, all our concrete products are made from 95% recycled natural materials that absorb CO2 during production, are 100% recyclable and release minimal greenhouse gas emissions.

## Colours



**Natural**  
Our most versatile shade, Natural is an organic concrete finish that seamlessly integrates into contemporary or traditional spaces.

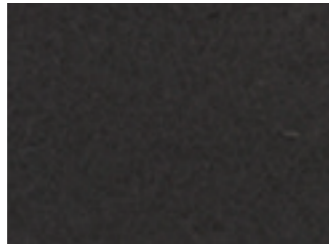

**Graphite**  
Sleek and modern, Graphite demands attention. Familiar yet fresh, Graphite complements a range of alfresco spaces.

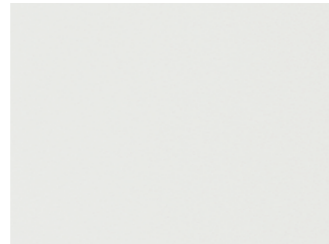

**Bone**  
A trendsetting finish with a clean and crisp texture. Bone is inspired by coastal tones and peaceful spaces.

## The Concrete

Fluid™ Concrete Technology uses a custom composition of green cement combined with 95% recycled natural materials.

Our special moulding process incorporates multiple layers of structural meshing combined with a carefully mixed slurry to produce a high-quality and dimensionally stable concrete that is relatively lightweight and incredibly strong.

With a curing process that allows each piece to rest and set in controlled conditions, we are able to produce consistently beautiful products that are built to last.

## The Coating

Developed in-house by our research and development team and a highly experienced German coating supplier, Fluid™ products are coated with a water-resistant barrier to ensure the green concrete composite shell becomes totally inert and isn't subject to temperature fluctuations or moisture saturation.

Each product is fully enveloped in a specially formulated solvent-based solution that protects the raw materials from environmental weathering. This enables us to deliver perfection from the base raw materials right through to the finished product - working from the inside out, to achieve an exceptionally robust product that is purpose built.

## Features and Benefits



**Eco-friendly**  
Made from a combination of green cement and 95% recycled natural materials that absorb CO2 during the curing process, our composites are 100% recyclable and release minimal greenhouse gas emissions.



**Quality Control**  
Every piece is marked with a unique serial number for quality control and traceability purposes. They're also dimensionally stable with low expansion and contraction rates.

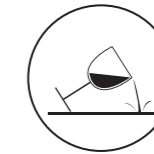

**Stain Resistant**  
Rigorous testing confirms the surface is impervious to ethanol, wine, vinegar, oil, mustard, tomato ketchup, salt, soy, bleach, espresso coffee, window cleaner, and more. (Turmeric should be avoided.)



**Environment Resistant**  
Fluid™ concrete is resistant to water, fire, insects, termites, mold and mildew. Fully cured, non-hydraulic concrete does not retain water, meaning it is resistant to freezing and thawing.

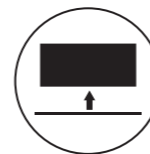

**Lightweight**  
Sturdy yet lightweight composition creates easily relocated furniture solutions.

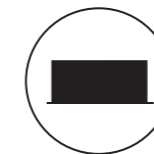

**Seamless Construction**  
We generate and work with moulds capable of producing unibody products which are seamless and free from join lines.

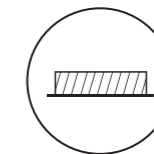

**Durable Surface**  
An exceptionally strong adhesion creates a coating that does not flake, peel or crack, and can withstand extreme weather variations and long UV exposure.



**Easy Care**  
Clean with mild soap and warm water using a soft cloth. Apply polymer car wax polish twice a year to nourish and protect, it also adds depth to the finish and brightens surface pigments.

# Sunbrella® Fabric



**BLINDE DESIGN ONLY USES SUNBRELLA®, THE WORLD'S NUMBER ONE OUTDOOR PERFORMANCE FABRIC THAT IS HIGHLY DURABLE, WATER-REPELLENT AND STAIN, FADE AND UV RESISTANT.**

Sunbrella® fabric's flat, consistent weaves gives it a smooth softness with an easy-care finish and being colourfast, they retain their good looks for many years.

Blinde's upholstered cushions and scatter cushions come in a choice of Sunbrella's three natural, contemporary colours – Flanelle, Sooty and Canvas – and are resistant to stains, mildew, mould and fading. The perfect choice for outdoor settings and for entertaining indoors.

## Colours

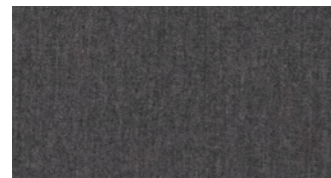

Flanelle



Sooty

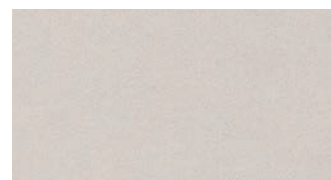

Canvas

## Features and Benefits

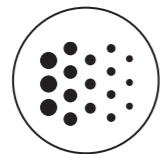

**UV and Fade Resistant**  
Sunbrella® fabrics are highly UV resistant, holding their colour even when exposed to the sun, salt and chlorine of harsh environments.

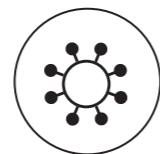

**Mould and Mildew Resistant**  
Mould and mildew will not inherently grow on Sunbrella® fabrics. Simply brush off dirt and debris to keep the fabrics clean.



**Easy Care**  
Sunbrella® fabrics can be spot cleaned with mild soap. They can also be cleaned with bleach, without losing its vibrant colour.

# Natural Teak Wood



**TEAK WOOD HAS A DEMONSTRATED ABILITY TO WITHSTAND THE HARSH EFFECTS OF THE WEATHER AS IT HAS A NATURAL OIL THAT REPELS WATER AND STOPS IT WARPING, CRACKING OR BECOMING BRITTLE.**

The hardwood's incredible strength and durability have made it the world's most premium timber and an ideal choice for outdoor furniture.

Teak wood is also low maintenance, requiring an occasional wash with soapy water and a soft nylon brush to remove pollen and dirt and a coating of natural oil as needed to protect the surface from stains and keep it looking its best.

The Teak used as a finish in our range of chairs is "A" Grade and TRIC Certified (Tropical Rainforest International Certification) which means it is harvested from a sustainably managed forest or plantation.

## Colour

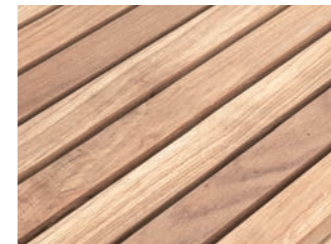

## Features and Benefits



**Durable**  
Teak's natural oil repels water and stops it warping, cracking becoming brittle, which helps teak retain its shape and good looks for many years.

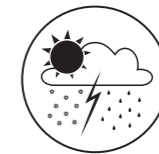

**Environment Resistant**  
Teak can be left outside all year round, even in extreme weather conditions. Over time, untreated teak furniture exposed to sun and rain will turn silver grey. This process does not harm the strength or quality of the wood.



**Easy Care**  
Remove moss, dirt, and surface stains, with an occasional wash with soapy water and a soft nylon brush is all you need. Teak can be cleaned to bring back its golden colour no matter how old.



# Get to know MAD Design

## MAD Design

MAD Design is a family of globally recognized brands, champions innovative, eco-conscious solutions that elevate the beauty and comfort of all spaces.

Our brands:

**Blinde Design** furnishes both indoor and outdoor spaces effortlessly and elegantly. Constructed with durable weather-resistant materials and on-trend styles.

**EcoSmart Fire** delivers limitless fireplace solutions with advanced and diverse fuel technologies to cater to every project's requirement.

**Heatscope Heaters** revolutionize the outdoor warming experience with sleek silhouettes and an emphasis on discreetly providing comfortable, sunlike warmth.

**e-NRG**, our bioethanol fuel, leads the market with its superior flame performance and extended burn time.

With MAD Design, you can rest assured that your space embodies the timeless elegance and superior performance it deserves.

## Join Us

Follow us for the latest product updates, special promotions, and weekly design inspiration. Don't forget to tag us for a chance to have your project featured!

Follow us

[@blindedesign](#)

[@ecosmartfire](#)

[@heatscopeheaters](#)

[@maddesigngroup](#)

to inspire your next project!

CONNECT >  
Modular Sofa

NICHE L50  
Coffee Table

Reproduction of this catalogue in any manner, in any language, in whole or in part without prior written permission is prohibited. MAD Design Group reserves the right to correct any errors or misprints. We also reserve the right to alter information without notification. The information provided herein is believed to be correct but is not guaranteed.



blinde  
design  
.com

blinde.<sup>TM</sup>